

# Data Sheet



Article number: 604133038085

Description: Taper bored timing belt pulley  
HTD 38 14M 85 TL 3020

## Measures

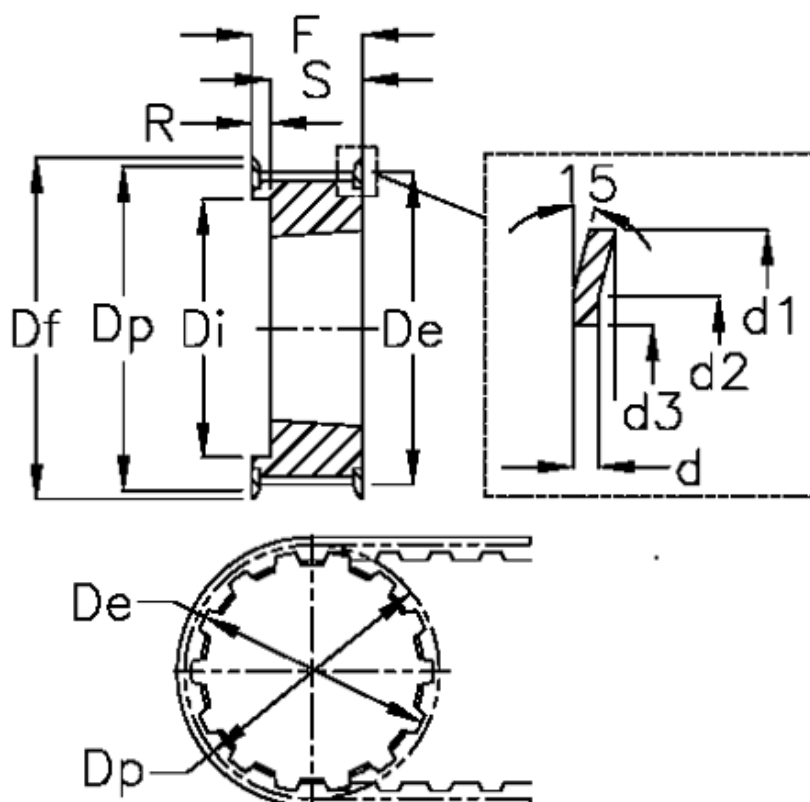

$d = 2.5$	F = 102	Weight = 6.8
$d1 = 184$	Flange type = F55	Width = 85
$d2 = 168$	For bushing = 3020	
$d3 = 135$	Max bore = 75	
$De = 166.6$	r = 25.5	
$Df = 184$	S = 51	
$Di = 130$	Tooth number = 38	
$Dp = 169.34$	Type = 14M	